

DS-MCW409UHK Body Camera



- 2688 × 1512 recording.
- Max. 40 M (8832 × 4960) resolution of the captured picture.
- IR function to recognize the facial features in the captured picture even in dim environment.
- Waterproof, dustproof, and anti-fall with 2 m fall protection height, applicable to all-day fieldwork.
- 4G/Wi-Fi network connection with flexible wireless transmission.
- Replace the battery without powering off.
- Supports real-time video transmission with 1080P/720P resolution.
- Electronic Image and Video Stabilization (EIS)

▪ Specification

Camera	
Image Sensor	1/3" progressive scan CMOS
Max. Recording Resolution	2688 × 1512
Min. Illumination	Color: 0.11 Lux @ (F22, AGC ON), 0 Lux with supplement light
Day & Night	Switch IR cut filter automatically
White Light	Supported
Lens	
FOV	Horizontal FOV: 132°, Vertical FOV: 72°, Diagonal FOV: 148°
Aperture	F2.2
Focal Length	2.4 mm fixed lens
Video	
Video Format	MP4, PS
Pre-record & Post-record	Pre-record: 60/10/5/3 s, Post-record: 60/10/5/3 s
Sub-Stream	30 fps (1280 × 720, 720 × 576)
Main Stream	60 Hz: 30 fps / 15 fps / 5fps (2688 × 1512, 1920 × 1080, 1280 × 720, 720 × 576)
Video Compression	H.264, H.265
Audio	
Audio Compression for Video Recording	AAC, G722
Audio Compression for Audio Recording	PCM
Audio Compression for Group Intercom	G711.A, G711.U, G722
Audio Bit Rate	G722 (16 kbps), AAC (dynamic), PCM (256 kbps), G711.A (64 kbps), G711.U (64 kbps)
Image	
Resolution	40 M (8832 × 4960), 30 M (7296 × 4104), 16 M (5312 × 2988), 5 M (3072 × 1728)
Image Format	JPEG
Screen	
Screen Size	2.4"
Touchscreen	Supported
Display Resolution	320 × 240
Storage	
RAM	2 GB
ROM	32 GB by default, 64/128/256 GB optional
IR	
IR Range	Up to 10 m, Illumination range greater than 90%
IR Wavelength	850 nm
Wireless Network	
Wi-Fi Protocol	802.11 a/b/g/n/ac
Positioning Mode	GPS, GLONASS
Wi-Fi Frequency Band	2.412 to 2.472 GHz, 5.15 to 5.25 GHz, 5.725 to 5.875 GHz
Bluetooth	BT4.0
Cellular Network	GSM: 850/900/1800/1900, WCDMA: B1/B2/B4/B5/B8, FDD-LTE: B1/B2/B3/B4/B5/B7/B8/B20/B28, TDD-LTE: B38/B39/B40/B41

Network	
Protocol	HTTPS, RTSP, NTP, FTP
API	ISAPI, SDK, ISUP
Interface	
Audio Type	2 built-in mic(s), 1 speaker(s)
Indicator	2 indicator(s) for charging/working/recording/exception
Button	Power, Video recording, PTT, SOS, Picture capture, Audio recording
Charging Interface	Type-C, Pogo Pin
Laser Positioning	Supported
USB	1 USB 2.0 port(s)
SIM Card	1 Nano-SIM card(s)
General	
Operating System	Android 9.0
Power	5 VDC, 2.0 A, max. 10 W
Weight	194.5 g (without mounting) (0.4 lb.)
Dimensions	92.8 mm × 59.7 mm × 28.5 mm (3.7" × 2.4" × 1")
Speaker	1 built-in speaker(s), max. power consumption: 1 W, max. sound pressure level: 95 dB (10 cm)
Client	HikCentral Pro, HikCentral Master
Operating Condition	-20 °C to 55 °C (-4 °F to 131 °F). Humidity 95% or less (non-condensing)
Battery	
Battery Life	Up to 12h in 720p resolution ¹
Embedded Sub-Battery	50 mAh
Charging Time	≤ 4 h
Battery Type	Lithium-ion battery, dismountable
Capacity	3300 mAh
Approval	
EMC	CE-EMC: EN 55032: 2015, EN 61000-3-2: 2019, EN 61000-3-3: 2013, EN 50130-4: 2011 +A1: 2014
Safety	CB: IEC 62368-1: 2014+A11, IEC 62368-1: 2018, CE-LVD: EN 62368-1: 2014/A11: 2017, EN IEC 62368-1: 2020+A11: 2020, CE-LVD: EN 62368-1: 2014/A11: 2017
Protection	IP68: IEC 60529-2013, MIL-STD-810G 2 m anti-drop
RF	EN 300 328 V2.1.1 (BT or 2.4 G), EN 62311: 2008 (BT or 2.4 G), EN 55032: 2015, EN 61000-3-2: 2014, EN 61000-3-3: 2013, EN 50130-4: 2011+A1: 2014), CE-RED: EN 300 330 V2.1.1
Environment	CE-RoHS: 2011/65/EU, WEEE: 2012/19/EU, Reach: Regulation (EC) No 1907/2006, CE-RoHS: EN IEC63000: 2018

This is a basic estimation of battery working life only when recording is on. Additional power consumption should be considered when IR, GPS, and/or network connection is on.

▪ Available Model

DS-MCW409UHK

▪ Dimension

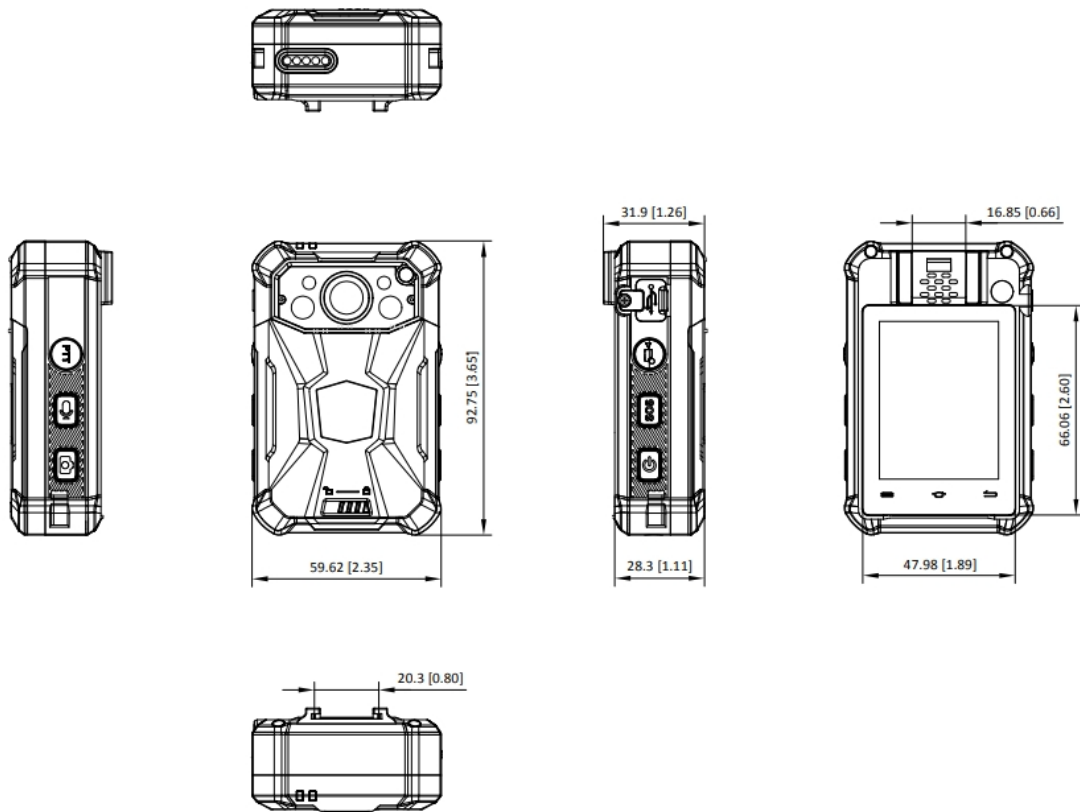



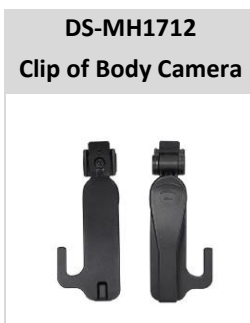

Unit: mm [inch]

- Accessory
- Included



▪ **Optional**

DS-MH1310-N1 (B) Body Camera Battery	DS-MH1711-HM Body Camera Chest Harness	DS-MH1721 Oblique Shoulder Harness	DS-MH1717 Body Camera - Magnetic Clip	DS-MH1716 Body Camera - Alligator Clip	DS-MH1715 Body Camera - Wearable Clip
					

Headquarters

No.555 Qianmo Road, Binjiang District,
Hangzhou 310051, China
T +86-571-8807-5998
www.hikvision.com



Follow us on social media to get the latest product and solution information.

